

Forced Cooling Systems: Technical Parameters

Forced cooling systems by Power are specially designed for over-temperature protection and short-term increase in the capacity of cast resin and dry-type transformers. Thanks to the enhanced design of the forced cooling systems, power gain of a transformer can reach up to 40% from rated power. Our ventilation systems are available in 4 models, consisting of 4 to 12 tangential fans and fit for transformers from 400 up to 4000 kVA. The forced cooling systems are completely assembled in our factory and are easy to install on transformers from different manufacturers.

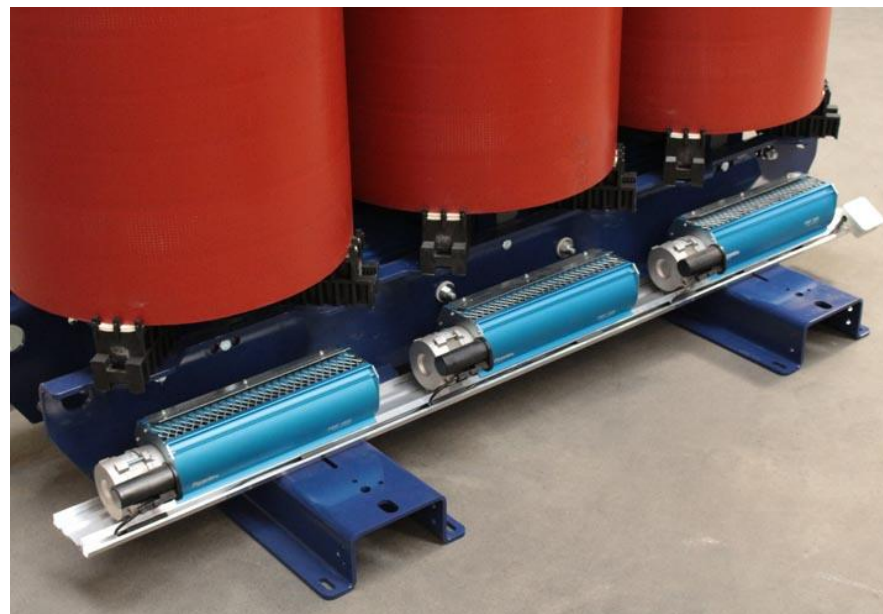

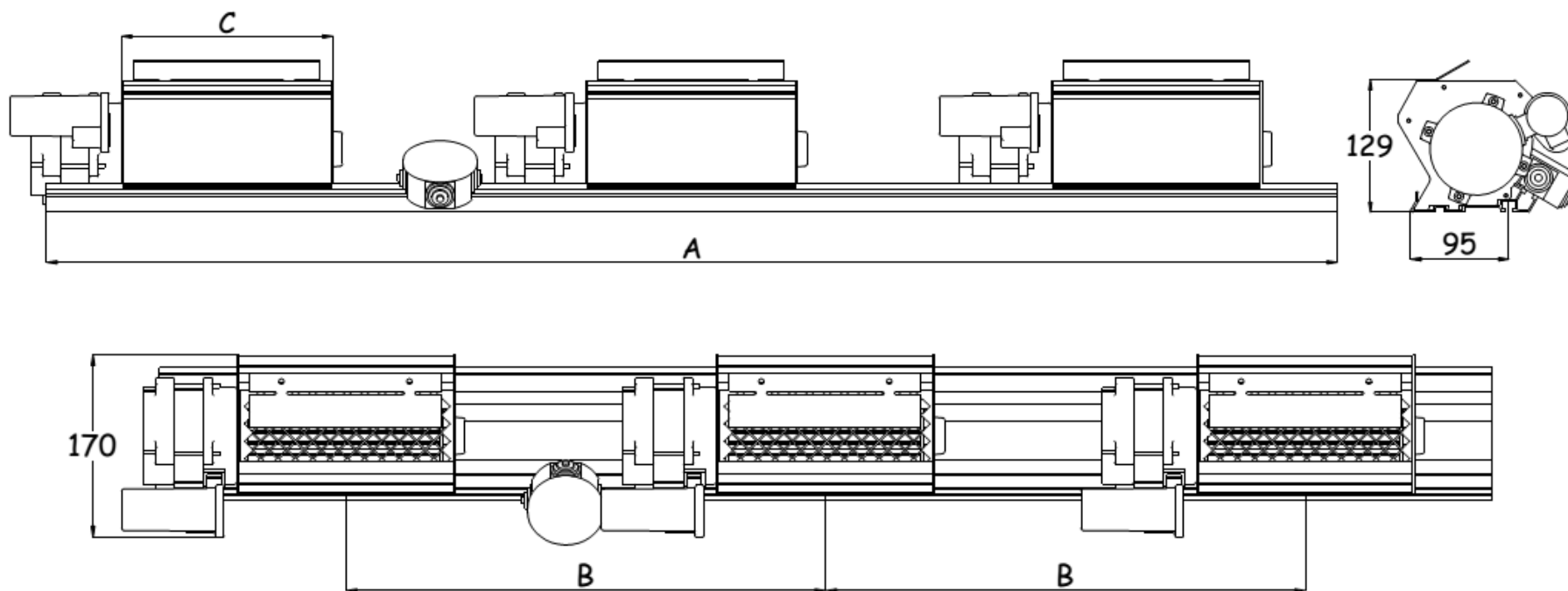

Type	Transformer rated power (kVA)	Capacity (m ³ /h)	A (mm)	B (mm)	C (mm)
PWF1200s	400 – 1000	~1200	1230	340-440	225
PWF1200	400 – 1000	~1200	1400	440-550	225
PWF1800	1250 – 2500	~1800	1850	530-720	405
PWF3600	3150 – 4000	~3600	2250	650-720	545